



Apton

... design your sky





04 AP 101 Lay in Ceiling



12 AP 103 Linear Strip Ceiling



16 AP 104 Open Cell Ceiling



08 AP 102 Clip in Ceiling



20 AP 105 Design Ceiling



Apton
...design your sky

- 04 - AP 101 LAY IN CEILING
- 08 - AP 102 CLIP IN CEILING
- 12 - AP 103 LINEAR STRIP CEILING
- 16 - AP 104 OPEN CELL CEILING
- 20 - AP 105 DESIGN CEILING
- 24 - AP 101 T24 & AP 101 T15 GRID SYSTEMS
- 25 - AP 102 CLIP IN GRID SYSTEM
- 26 - PERFORATION TYPE
- 27 - APTON CEILING PERFORMANCE

AP 101 LAY IN CEILING

System Description:

AP 101 Lay in Ceiling Tiles are designed to be installed in conventional T grid system. This system is considered to be 100% accessible, a modular ceiling system in flat and recessed lay in and lay on tile and used specially in area where regular maintenance is needed such as kitchens, computer rooms, hospitals and offices etc. The AP 101 Lay in ceiling or panels are suitable to be fixed on different types of grid exposed system such as T24mm, T15mm. Materials can be either powder coated or pre painted metal sheet. Before selecting this system, care should be taken to ensure that there is enough space in the plenum to lift the tiles upwards.



AP 101 LAY IN CEILING KEY FEATURES

- Easy to access panels
- It's widely used in contemporary interior design
- Stable interlocking exposed grid system
- Ceiling Lights and grilles easily integrated
- Durable, washable, smooth polyester coating
- Streamline design



AP 101 LAY IN CEILING SPECIFICATIONS

System: AP 101 Lay in Ceiling system

Tile Materials: Galvanized steel sheet (aluminum or other materials on request)

Standard modules: 600 X 600mm, 600 X 1200mm, 1200 X 1200mm

Grid System: AP 101 T24mm, T15mm Grid system

Coating: RAL 9010 pure white post – coated powder painted surface, anti-bacterial coating & other color available on request

Acoustic Inlay: Black non – woven acoustic fleece as standard. Other options available on request

Perimeter Solution: Range standard Perimeter Trim in steel and aluminum available

Shape: Tiles are square with out-turned flanges laid onto the exposed grid system

Perforation: D. 1.5mm, D. 1.8mm, D. 2.5mm (Full details in perforation options page)

AP 101 Lay in Grid System

Apton

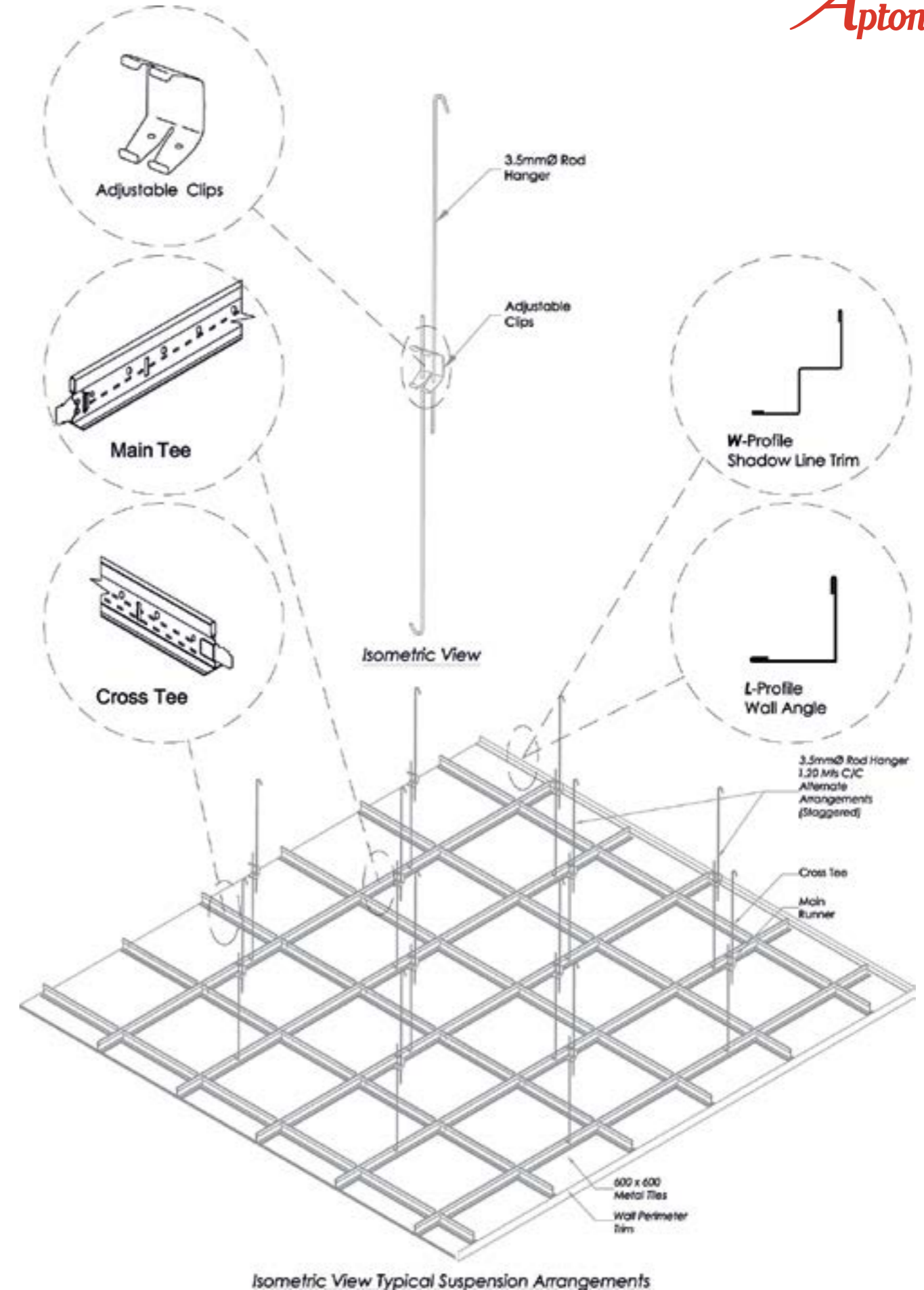

AP 102 CLIP IN CEILING

System Description:

AP 102 Clip in Ceiling is the most widely used metal ceiling system. The tiles, manufactured to fine press tool tolerances are clipped into a concealed clip in grid system. Tiles are automatically levelled in the grid by special twin pip arrangements which are pressed into side the flanges of the tiles during manufacture.



AP 102 Clip in Ceiling Key Features:

- Concealed grid system
- Hinge down access throughout
- Closed butt joints with beveled edges
- Modular or circular light fitting or grills can be integrated within the clip in system
- Secure void, easy to access tool required to demount tile
- Streamline design

AP 102 Clip in Ceiling Specifications:

System: AP 102 Clip in Ceiling system

Tile Materials: Galvanized steel sheet (aluminum or other materials on request)

Standard modules: 600 X 600mm, 600 X 1200mm, 1200 X 1200mm

Grid System: AP 102 Clip in Grid system

Coating: RAL 9010 pure white post – coated powder painted surface, anti-bacterial coating & other color available on request

Acoustic Inlay: Black non – woven acoustic fleece as standard. Other options available on request

Perimeter Solution: Range standard Perimeter Trim in steel and aluminum available

Shape: Tiles are available with a square edge, incorporating a hinging tab and pip locating details.

Perforation: D. 1.5mm, D. 1.8mm, D. 2.5mm (Full details in Perforation options page)



AP 102 Clip in Grid System

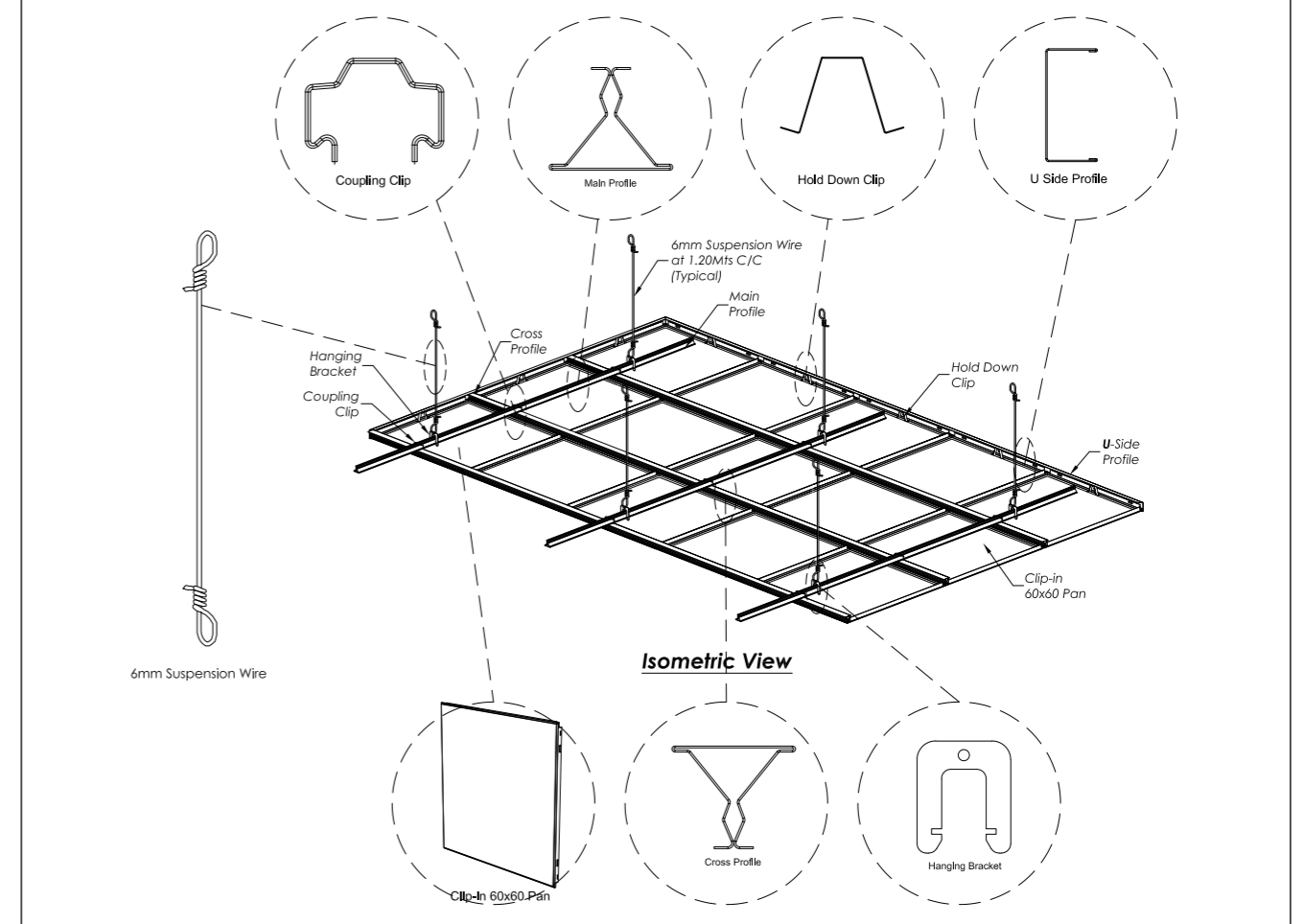





AP 101 T24 & AP 101 T15 GRID SYSTEMS

| Item Name | Description | Materials | Dimension |
|---|----------------------|------------|---------------------------------------|
|  | 24 Main Runner | Galvanized | 24 X 38 X 3600 mm |
|  | 15 Main Runner | Galvanized | 15 X 38 X 3600 mm |
|  | 24 Cross Tee 1200 | Galvanized | 24 X 26 X 1200 mm |
|  | 15 Cross Tee 1200 | Galvanized | 15 X 28 X 1200 mm |
|  | 24 Cross Tee 600 | Galvanized | 24 X 26 X 600 mm |
|  | 15 Cross Tee 600 | Galvanized | 15 X 28 X 600 mm |
|  | 24 Wall Angle | Galvanized | 19 X 19 X 3000 mm |
|  | 15 Shadow Wall Angle | Galvanized | 19 X 15 X 6 X 15 X 3000 mm |
|  | Butterfly Clip | Galvanized | Butterfly Clip steel 0.5mm |
|  | Rod Hangers | Galvanized | Wire Rod Hangers 3/4 \varnothing mm |

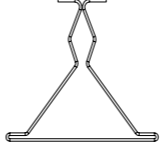
AP 102 CLIP IN GRID SYSTEM

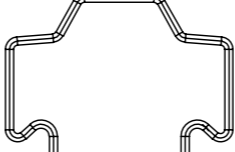

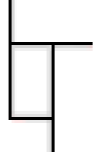
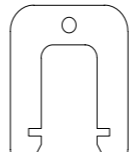
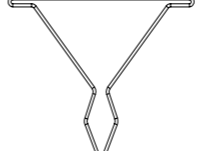
| Item Name | Description | Materials | Dimension |
|---|-----------------------|------------------|------------------------------|
|  | Main Profile | Galvanized Steel | 37 X 15 X 4000 mm |
|  | Omega Carrier Joint | Galvanized Steel | 60 X 4 X 15 mm |
|  | Omega Coupling Clip | Galvanized Steel | 5 X 15 X 40 mm |
|  | Edge Trim | Aluminium | 15 X 38 X 15 X 3000 mm |
|  | Shadow Line Edge Trim | Galvanized Steel | 45 X 15 X 38 X 15 mm |
|  | Hanging Bracket | Galvanized Steel | Hanging Bracket Steel 0.5 mm |
|  | Cross Profile | Galvanized Steel | Cross Profile Steel 0.5 mm |

AP 103 LINEAR STRIP CEILING

System Description:

AP 103 Linear Strip Ceiling gives decorative style and modernity with square edge strips. AP 103 Linear Strip ceiling having closed and open panel strips showing a channel between strips depends upon your decoration needs. Clip Sets, hanging wires and metal ceiling strips are used for installation.



AP 103 Linear Strip Ceiling Key Features:

- This system give a smooth view depending on the decoration taste
- This system can absorb high levels of noise and it can be used both internally and externally
- The panels can be easily removed and replaced by using hooked-shaped tool allowing easy and full access to the plenum.
- Absence of dust retention and ease of cleaning make this ceiling (plain panel) ideal for anywhere where hygiene is important



AP 103 Linear Strip Ceiling Specifications:

System: AP 103 Linear Strip Ceiling system

Tile Materials: Galvanised steel sheet (aluminum or other materials on request)

Standard modules: 50mm, 100mm, 200mm, 300mm

Grid System: AP 103 Carrier system

Coating: RAL 9010 pure white post – coated powder painted surface, anti-bacterial coating & other color available on request

Acoustic Inlay: Black non – woven acoustic fleece as standard. Other options available on request

Perimeter Solution: Range standard Perimeter Trim in steel and aluminum available

Perforation: D. 1.5mm, D. 1.8mm, D. 2.5mm

(Full details in Perforation options page)



AP 104 OPEN CELL CEILING

System Description:

AP 104 Open Cell Ceiling is a range of aluminum open cell ceiling panels that are designed to lay onto 15mm grid system. Access is gained by simply lifting the panels out of the grid. Open Cell Ceiling blends in with the Tee grid to give a monolithic appearance.

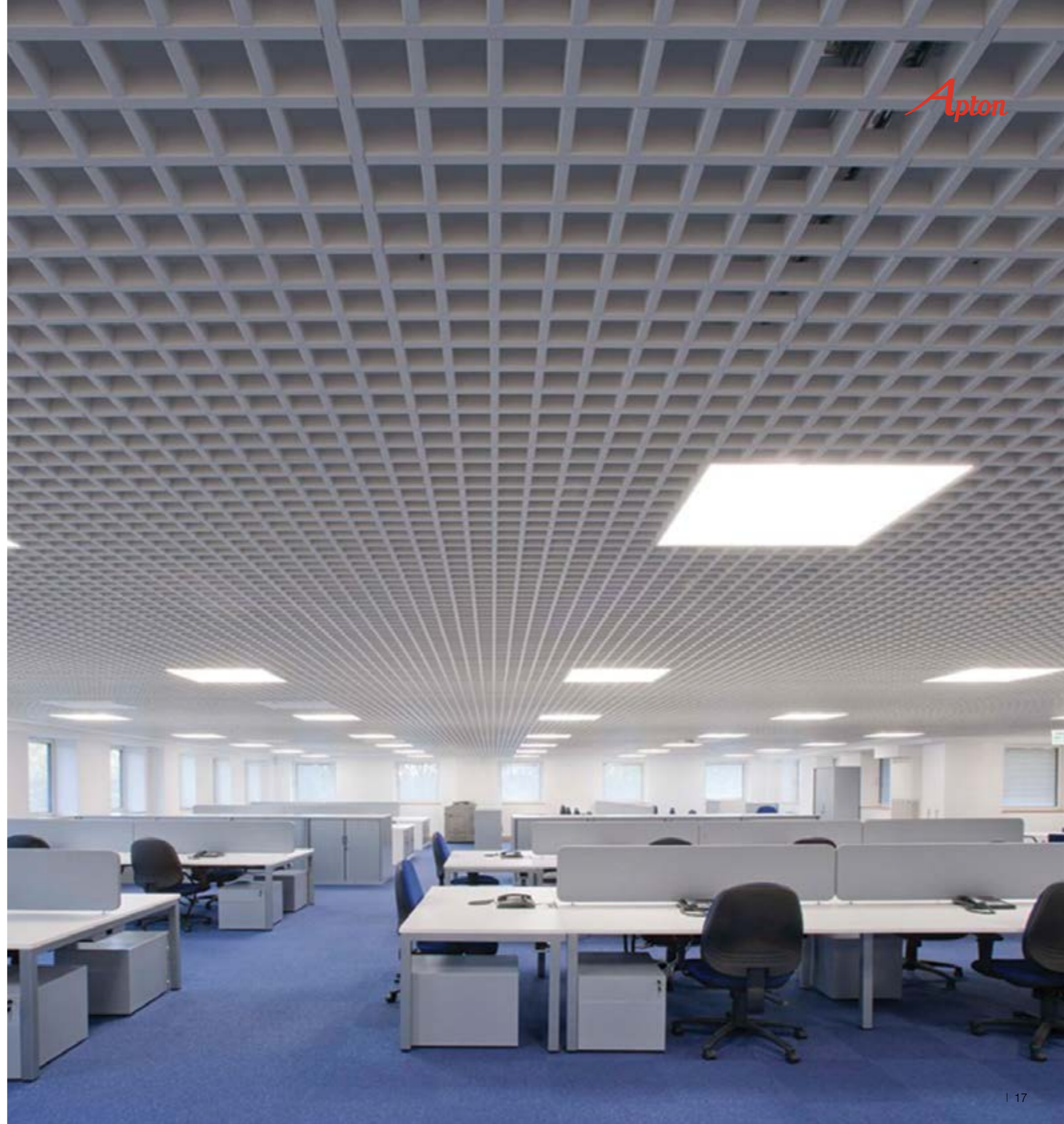
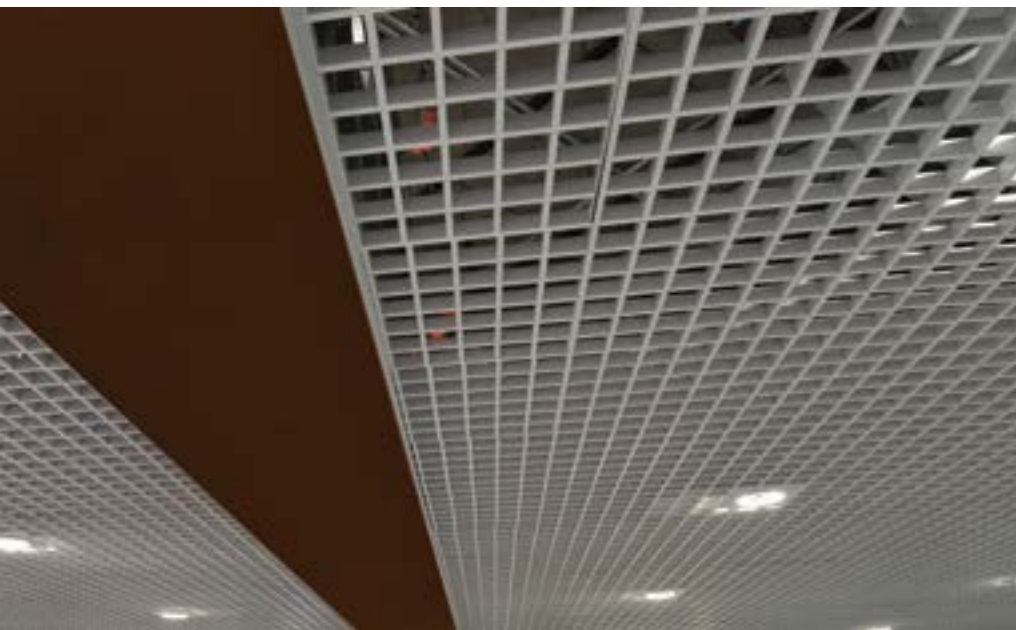

AP 104 Open Cell Ceiling Key Features:

- Strong modular appearance
- Because the system is cell-formed, it allows air circulation behind the ceiling
- This system allows varied light fixture application so that it provides different designed alternatives for projects
- Create decorative and functional open ceiling environments



AP 104 Open Cell Ceiling Specifications:

System: AP 104 Open Cell Ceiling system

Tile Materials: Aluminum

Standard modules: 150mm, 100mm, 75mm, 50mm (Module)

Grid System: AP 101 T15mm Grid system

Coating: RAL 9010 pure white post – coated powder painted surface & other color available on request

Perimeter Solution: Range standard Perimeter Trim in steel and aluminum available



Apton



AP 105 DESIGN CEILING

System Description:

AP 105 Design Ceiling systems can be made in a variety of metals and techniques. Apton works with designers to create custom overhead systems, including interior ceiling design as well as exterior canopy and soffit systems.



Apton



AP 105 Design Ceiling Key Features:

- With our Design Ceiling capabilities you can create a monolithic look with extra-wide metal panels or a radial effect with trapezoids tailored to fit your space
- Faceted, flat, or curved, custom metal ceilings have the unique sizes, shapes, finishes, and perforations to make your next project standout.
- Ceiling tiles and panels can be used in variety of spaces and are available in both standard modules and custom dimensions to suit your project

AP 105 Design Ceiling Specifications:

System: AP 105 Design Ceiling system
Tile Materials: Galvanized steel sheet (aluminum or other materials on request)
Standard modules: as per project required design
Grid System: as per project required design
Coating: RAL 9010 pure white post – coated powder painted surface & other color available on request
Perimeter Solution: as per project required design

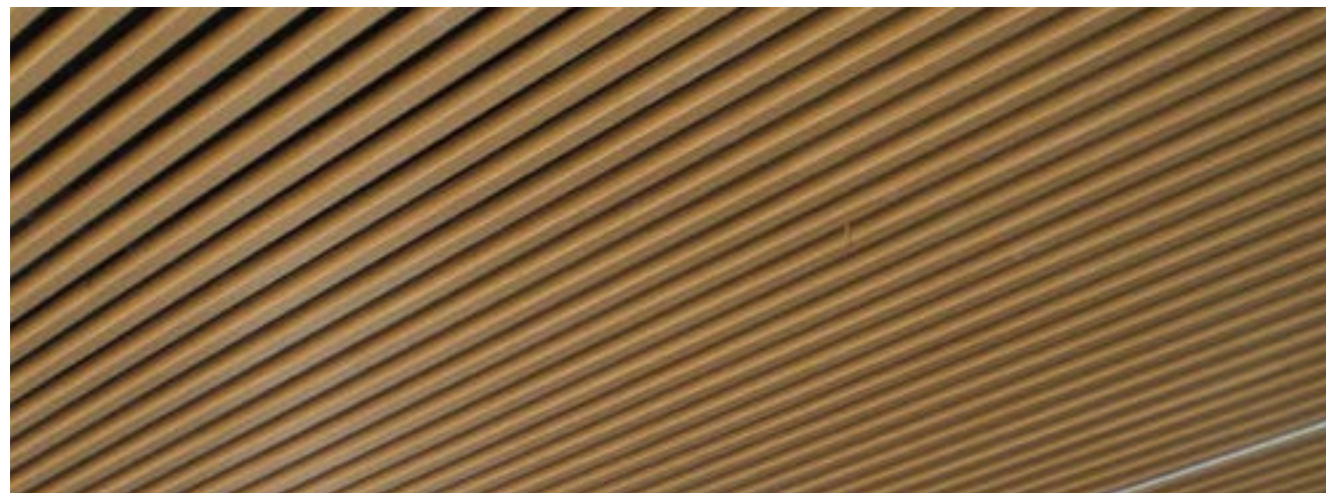

PERFORATION TYPE



Ø0.80 mm Straight Round Perforation

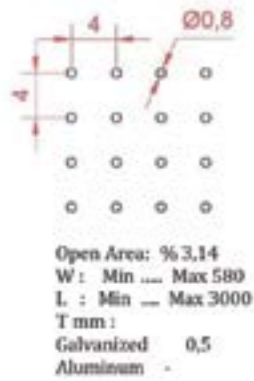

Ø1.50 mm Straight Round Perforation

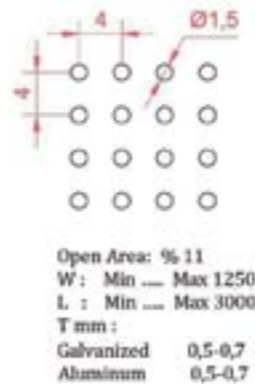

Ø1.80 mm Straight Round Perforation

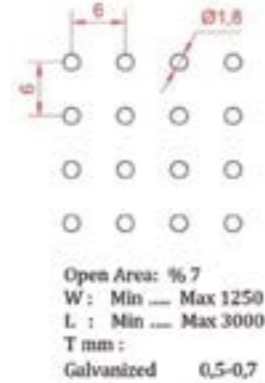

Ø3.00 mm Diagonal Perforation



Ø 15 x 30 Diagonal Perforation

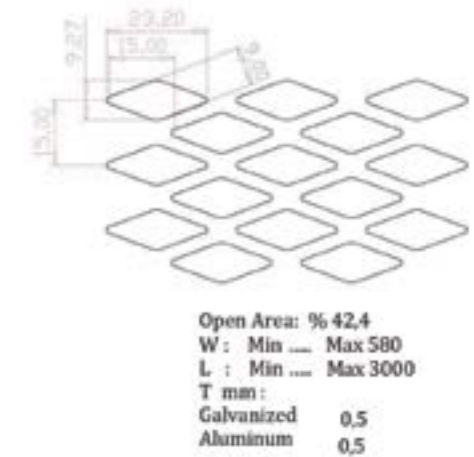

Ø2.50 mm Straight Round Perforation

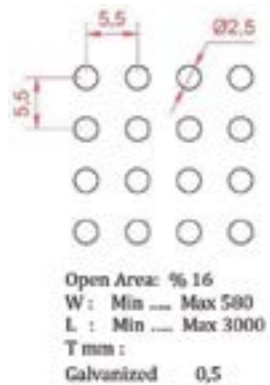

Ø8.00 mm Straight Square Perforation

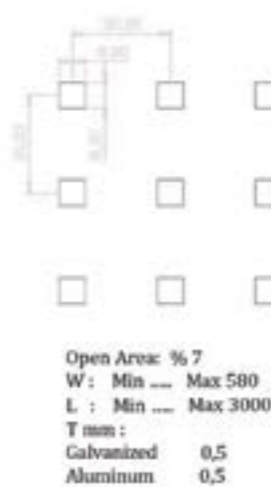

Ø8.00 mm Straight Round Perforation

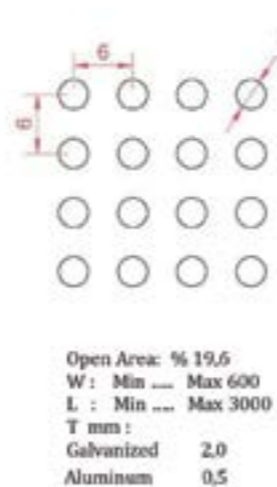

Ø0.80 mm Diagonal Perforation

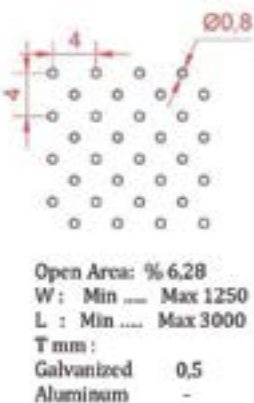

Ø1.50 mm Diagonal Perforation

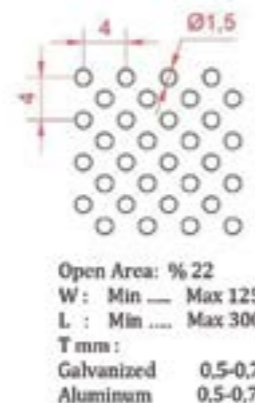

Ø1.80 mm Diagonal Perforation

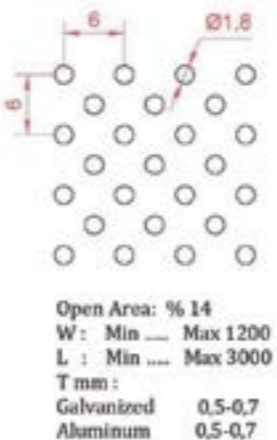

APTON CEILING PERFORMANCE

| | |
|---|---|
| 1. Unique identification code of the product-type: | "APTON" Metal Ceiling Systems |
| 2. Type, batch or serial number or any other element allowing identification of the construction product as required pursuant to Article 11(4): | Product Type, Order/Batch Nr. |
| 3. Intended use or uses of the construction product, in accordance with the applicable harmonized technical specification, as foreseen by the manufacturer: | Internally, to produce an installed suspended ceiling |
| 4. Name, registered trade name or registered trade mark and contact address of the manufacturer as required pursuant to article 11 (5): | Apton Metal Ceiling - United Kingdom Unit 3 Cannonn Business Park Gough Road Coseley West Midlands WV14 8XR Tel: +44 (0) 1902 385 250 / Tel: +44 (0) 1902 385 255 Email: enquiries@apton-ceiling.com www.apton-ceiling.com |
| 5. Where applicable, name and contact address of the authorized representative whose mandate covers the tasks specified in Article 12 (2): | Not Applicable |
| 6. System or systems of assessment and verification of constancy of performance of the construction product as set out in Annex V: | Systems 3 |
| 7. In case of the declaration of performance concerning a construction product covered by a harmonized standard: | (a)The manufacturer carrying out factory production control; (b)Turkish Standards Institution (TSE) /Notified Body No:1783 issued the Reaction to Fire classification report (Report No:TSE-19.01.2017-170050) according to TS EN 13501-1+A1:2013-04 as the notified testing laboratory (based on sampling carried out by the manufacturer). |
| 8. In case of the declaration of performance concerning a construction product for which a European Technical Assessment has been issued: | Not Applicable |

Apton



Apton Partitioning Limited –United Kingdom

Unit 3 Cannon Business Park Gough Road Coseley West Midlands WV14 8XR

Tel: +44 (0) 1902 385 250

Fax: +44 (0) 1902 385 255

Email: enquiries@apton-partitioning.com

www.apton-partitioning.com

